



LDSBus pH Sensor Adapter Datasheet



1 Introduction

The LDSBus pH Sensor Adapter is designed to work with pH probes to form a complete pH sensor. The adapter consists of a built-in BNC connector used to attach pH probes. The adapter and probe are calibrated using a 2-point calibration algorithm and supports measurement of pH ranging from 0 to 14 pH with a 0.01 pH resolution. The adapter and probe combination are suitable for use in applications such as nutrient tanks, water treatment plants, sewage treatment plants, swimming pools. Real time monitoring, alert notifications and control automation can be achieved.

1.1 Features

- pH Sensor Adapter to integrate with any pH probe with a BNC connector
- Measures pH range of 0 to 14pH with linearized output and 0.01 pH resolution
- 2 Point calibration guided step-by-step
- BRTSys's LDSBus protocol. Wired data/power transmission through LDSBus Quad T-Junction
- High report rate of 1 report every 5 seconds
- Low power consumption 5V-108mW
- Operating temperature range: 0°C to +70°C
- Flush Mount and DIN Rail Mount options
- Supported platform application: BRTSys's IoTPortal and LDSBus Python SDK

(Visit <https://brtsys.com/resources>)



Neither the whole nor any part of the information contained in, or the product described in this manual, may be adapted, or Reproduced in any material or electronic form without the prior written consent of the copyright holder. This product and its documentation are supplied on an as-is basis and no warranty as to their suitability for any particular purpose is either made or implied. BRT Systems Pte Ltd (BRTSys) will not accept any claim for damages howsoever arising as a result of use or failure of this product. Your statutory rights are not affected. This product or any variant of it is not intended for use in any medical appliance, device, or System in which the failure of the product might reasonably be expected to result in personal injury. This document provides preliminary information that may be subject to change without notice. No freedom to use patents or other intellectual property rights is implied by the publication of this document. BRT Systems Pte Ltd, 1 Tai Seng Avenue, Tower A, #03-01, Singapore 536464. Singapore Registered Company Number: 202220043R.

2 Part Numbers / Ordering Information

Part#	Description
LS040101A	LDSBus pH Sensor Adapter
LA120101A	LDSBus DIN Rail Mount Set

Table 1 – Part Number / Ordering Information

Table of Contents

1	Introduction	1
2	Part Numbers / Ordering Information.....	2
3	Specifications.....	4
4	Hardware Features.....	5
5	Sensor Configuration and Installation.....	6
5.1	Connection Diagram.....	6
6	Mounting Options	7
6.1	Flush Mount	7
6.2	DIN Rail Mount.....	7
7	System Status LED Indicators	8
7	Probe Selection	9
8	Mechanical Dimension.....	10
9	Contact Information.....	11
Appendix A – References		12
	Document References	12
	Acronyms and Abbreviations.....	12
Appendix B – List of Figures and Tables.....		13
	List of Figures	13
	List of Tables.....	13
Appendix C – Revision History		14

3 Specifications

Features	Interface	BNC (Connect to pH probe), RS485
	LED Indicator (RGB)	System Status Indicator (Please refer to LED section)
	Mounting	Flush Mount
DIN Rail Mount		
Power	Input Voltage	5V DC Bus Power
	Typical Power	5V 108mW
	Max. Power	218mW
pH Sensor input module	Range	0 – 14pH
	Resolution	0.01pH
	Response Time	<1Minute
	Calibration	2 Point Calibration
Physical Characteristics	Color	White
	Housing	Polycarbonate
	Dimensions	L117.6mm x W42.9mm x H29.7mm
Environmental Limits	Operating Temperature	0 to 70°C
	Storage Temperature	-20 to 85°C
	Ambient Relative Humidity	5 to 95% (non-condensing)
Package Contents	Device	1x LDSBus pH Sensor Adapter
	Wire Assembly	1X 5m RJ11 Cable
Optional	Mounting Accessories	1x LDSBus DIN Rail Mount set (LA120101A)

Table 2 - LDSBus pH Sensor Adapter Specifications

4 Hardware Features

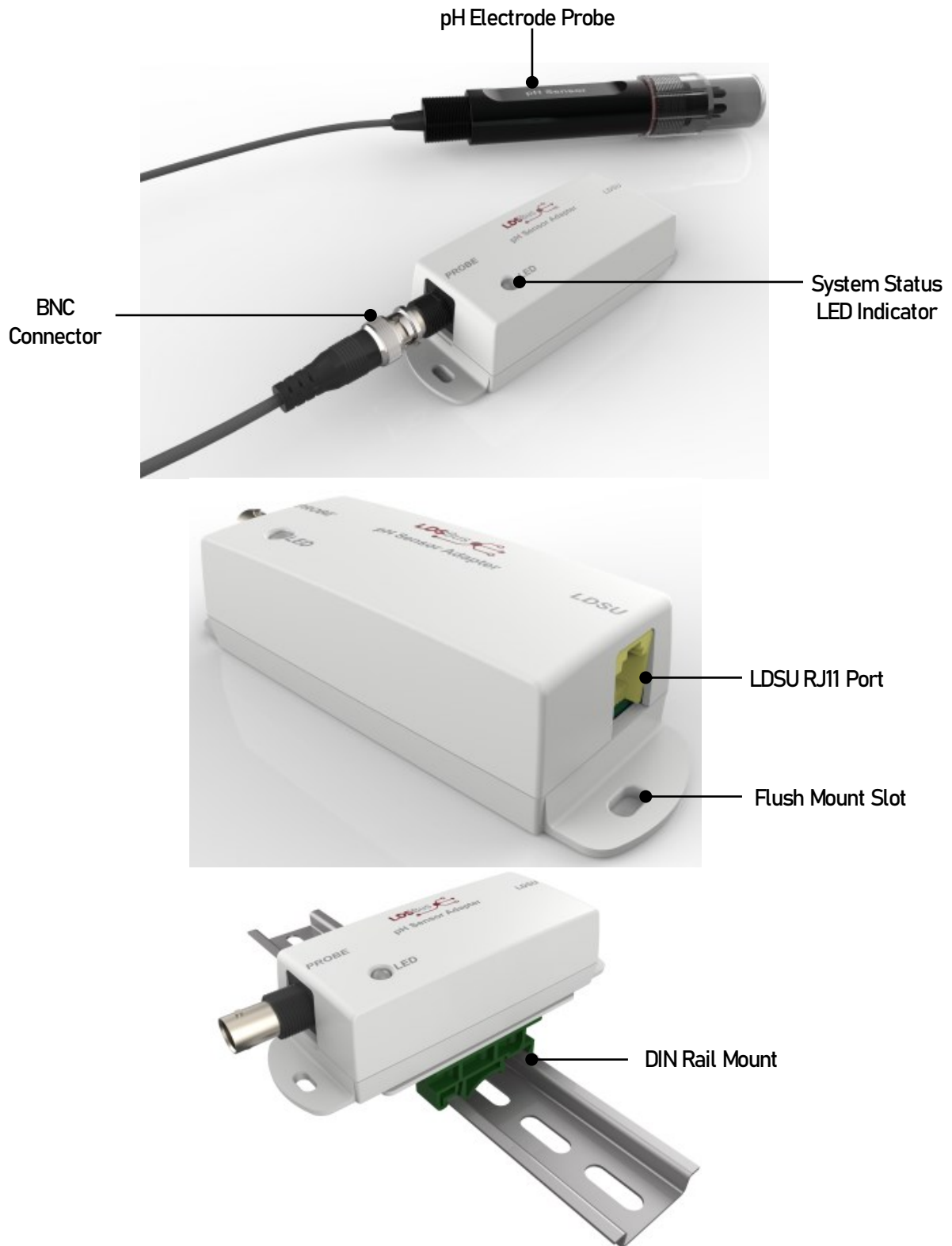

Figure 1 - LDSBus pH Sensor Adapter Hardware Features

5 Sensor Configuration and Installation

Please visit <https://brtsys.com/resources> to access the LDSBus Configuration Utility Guide on how to configure the device name, address, and termination settings before using it for your application.

5.1 Connection Diagram

Figure 2 illustrates the connection of the LDSBus pH Sensor Adapter (LDSBus Device) to the LDSBus. Please visit <https://brtsys.com/resources> to view the full device application, setup, and installation guides.

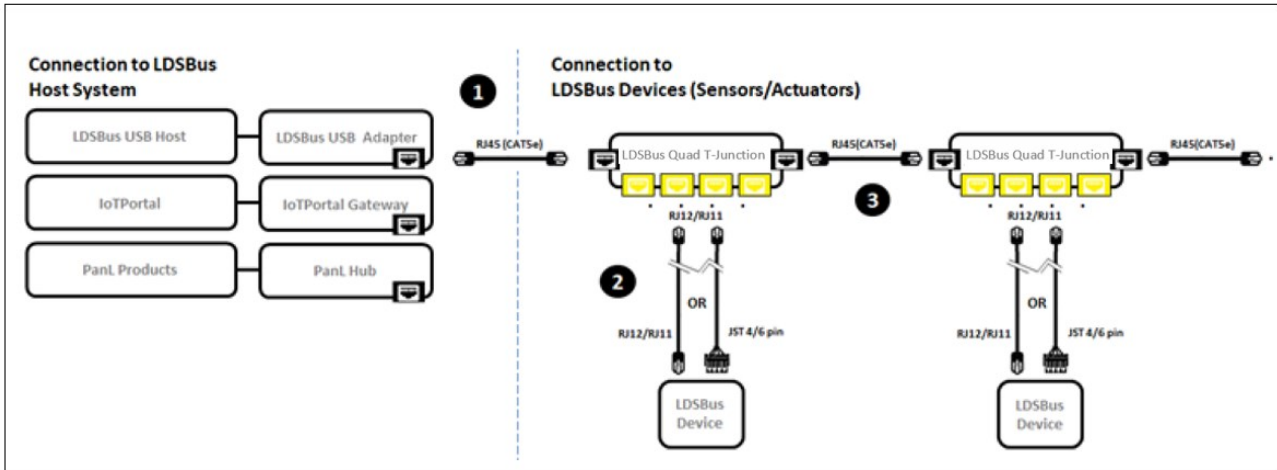

Figure 2 - LDSBus pH Sensor Adapter to LDSBus - Connection Diagram

Setup Instructions:

1. Connect the first LDSBus Quad T-Junction to any of the LDSBus Host Systems using the RJ45 (CAT5e) cable.
2. Connect the configured LDSBus pH Sensor to the LDSBus Quad T-Junction as shown in Figure 2.
3. If there is more than one LDSBus Quad T-Junction, chain them together as shown in Figure 2.

6 Mounting Options

6.1 Flush Mount

The LDSBus pH Sensor Adapter can be flush mounted directly on a wall or any flat surface using 2 M3.5*16mm (thread) screws.

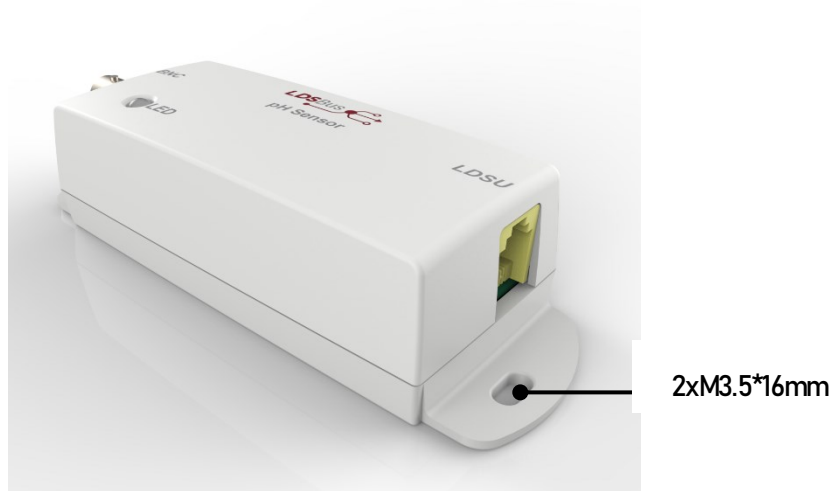

Figure 3 - LDSBus pH Sensor Adapter Flush Mount

6.2 DIN Rail Mount

The LDSBus pH Sensor can be mounted on a DIN Rail using the LDSBus DIN Rail Mount set. This set is optional and includes the bracket and mounting screws.



Figure 4 - LDSBus pH Sensor Adapter DIN Rail Mount

7 System Status LED Indicators

LDSU devices come with a tri-color LED, and LED status colors are mentioned in the table below.

Status display colors

1. RED - Device in error conditions
2. YELLOW - Un-configured device
3. GREEN - Device in normal state (Device termination is OFF)
4. BLUE - Device in normal state (Device termination is ON)









Device Status	LED Color		Flashing Frequency	Description
Un-configured device	YELLOW		LED flashing @1Hz	Un-configured device with factory default address (126)
Configured device	GREEN		Steady-Non-flashing	Configured device (Device ID 1-125) and device is idle.
	BLUE			
Addressed device	GREEN		LED flashing @5Hz	Device is busy communicating.
	BLUE			
Identified device	GREEN		LED flashing @1Hz	Device in identify state.
	BLUE			
Device error	RED		Steady - Non-flashing	Device error has occurred.
Firmware update	YELLOW		Steady - Non-flashing	Device firmware update.

Table 3 – LDSBus pH Sensor Adapter – System Status LED Indicator

7 Probe Selection

The following specifications are recommended for selecting a Probe -

pH Range	:	0~14pH
Connector Interface	:	BNC
Zero Point	:	Max. 7 ± 0.5 pH
Theoretical slope %	:	$\geq 90\%$ and $\leq 105\%$
Internal Resistance	:	$\leq 250M\Omega$

For more information on calibration, please refer to
[BRTSYS AN 001 LDSBus Configuration Utility Guide](#)

8 Mechanical Dimension

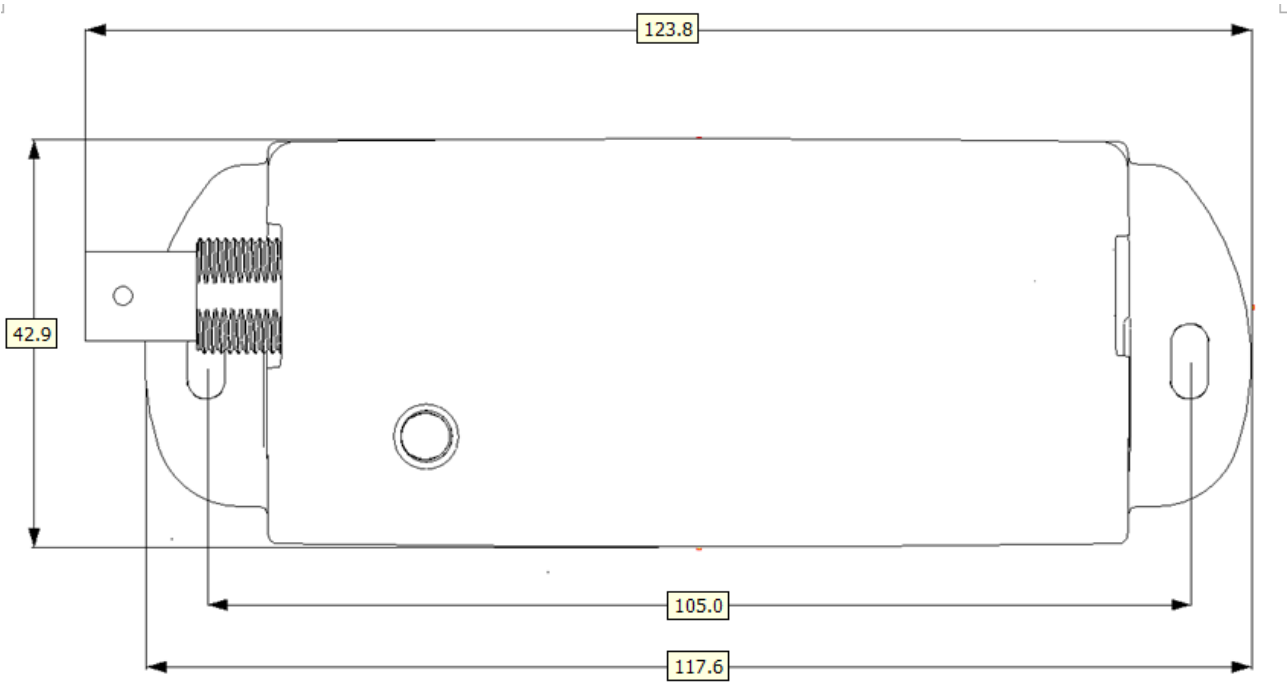

Figure 5 – LDSBus pH Sensor Adapter Dimension – Top View

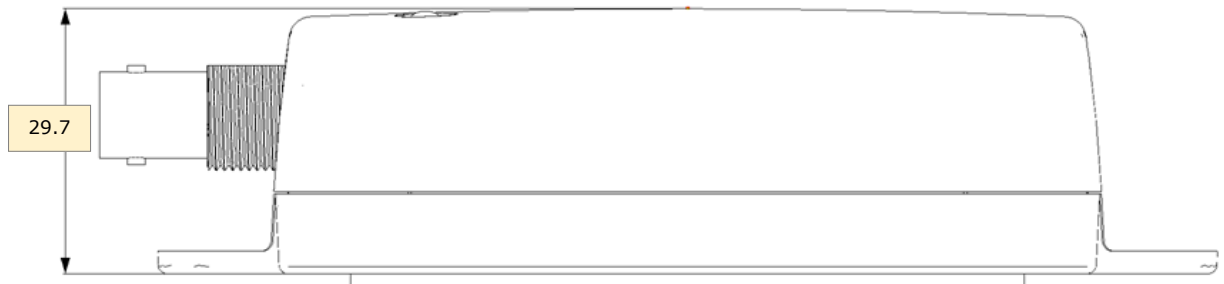

Figure 6 – LDSBus pH Sensor Adapter Dimension – Side View

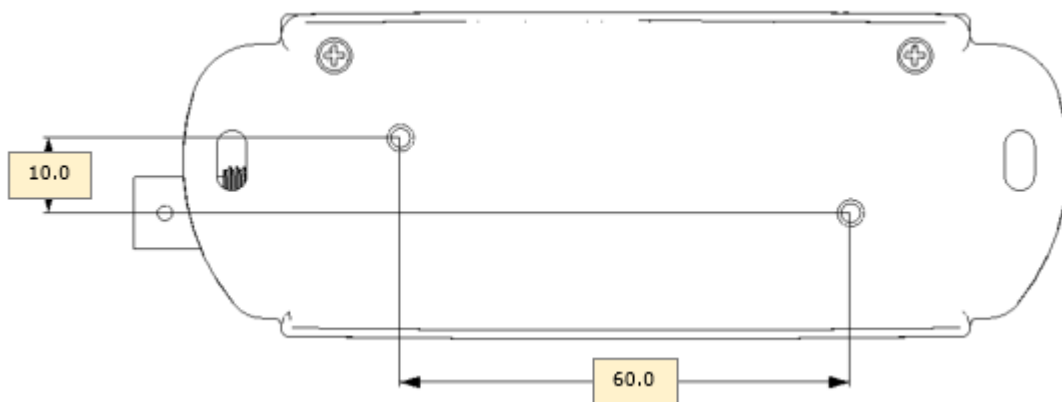

Figure 7 – LDSBus pH Sensor Adapter Dimension – Bottom View

Note: All dimensions are in millimetres.

9 Contact Information

Refer to <https://brtsys.com/contact-us/> for contact information.

System and equipment manufacturers and designers are responsible to ensure that their systems, and any BRT Systems Pte Ltd (BRTSys) devices incorporated in their systems, meet all applicable safety, regulatory and system-level performance requirements. All application-related information in this document (including application descriptions, suggested BRTSys devices and other materials) is provided for reference only. While BRTSys has taken care to assure it is accurate, this information is subject to customer confirmation, and BRTSys disclaims all liability for system designs and for any applications assistance provided by BRTSys. Use of BRTSys devices in life support and/or safety applications is entirely at the user's risk, and the user agrees to defend, indemnify, and hold harmless BRTSys from any and all damages, claims, suits, or expense resulting from such use. This document is subject to change without notice. No freedom to use patents or other intellectual property rights is implied by the publication of this document. Neither the whole nor any part of the information contained in, or the product described in this document, may be adapted, or reproduced in any material or electronic form without the prior written consent of the copyright holder. BRT Systems Pte Ltd, 1 Tai Seng Avenue, Tower A, #03-01, Singapore 536464. Singapore Registered Company Number: 202220043R.

Appendix A – References

Document References

[BRTSYS_AN_001_LDSBus_Configuration_UTILITY_Guide](#)

[BRTSYS_API_001_LDSBus_Python_SDK_Guide](#)

[Sensor_Actuator_Quick_Start_Guide](#)

Acronyms and Abbreviations

Terms	Description
DC	Direct Current
LED	Light Emitting Diode

Appendix B – List of Figures and Tables

List of Figures

Figure 1 - LDSBus pH Sensor Adapter Hardware Features	5
Figure 2 - LDSBus pH Sensor Adapter to LDSBus - Connection Diagram	6
Figure 3 - LDSBus pH Sensor Adapter Flush Mount	7
Figure 4 - LDSBus pH Sensor Adapter DIN Rail Mount.....	7
Figure 5 - LDSBus pH Sensor Adapter Dimension - Top View.....	10
Figure 6 - LDSBus pH Sensor Adapter Dimension - Side View.....	10
Figure 7 - LDSBus pH Sensor Adapter Dimension - Bottom View.....	10

List of Tables

Table 1 - Part Number / Ordering Information	2
Table 2 - LDSBus pH Sensor Adapter Specifications	4
Table 3 - LDSBus pH Sensor Adapter - System Status LED Indicator	8

Appendix C – Revision History

Document Title: LDSBus pH Sensor Adapter Datasheet
Document Reference No.: BRTSYS_000004
Clearance No.: BRTSYS#012
Product Page: <https://brtsys.com/ldsbus/>
Document Feedback: [Send Feedback](#)

Revision	Changes	Date
Version 1.0	Initial Release	18-11-2021
Version 1.1	Updated release under BRT Systems	15-09-2022
Version 1.2	Corrected BRTSYS to BRTSys	24-03-2023
Version 1.3	Updated the following – HVT references to Quad T-Junction; Singapore address	11-09-2023
Version 1.4	Updated Section 3. Specifications	04-09-2024