



LDSBus Thermocouple Sensor Adapter Datasheet



1 Introduction

The LDSBus Thermocouple Sensor Adapter is designed to operate with any K-type thermocouple probe and provides temperature measurements ranging between -200°C to 1372°C with an accuracy of $\pm 0.5^{\circ}\text{C}$. The adapter automatically handles all the necessary signal conditioning and analog to digital conversions to produce linearized temperature readings and can sustain high report rates. The LDSBus Thermocouple Sensor Adapter may be used in applications such as food production, metal extruders, furnaces, cryogenic baths, and freezers to name a few.

1.1 Features

- Thermocouple Sensor Adapter connects with any K-type Thermocouple probe
- Measures Temperature in the range of -200°C to 1372°C with an accuracy of $\pm 0.5^{\circ}\text{C}$
- Automatic cold junction compensation and linearization for high accuracy readings
- BRTSys's LDSBus protocol. Wired data/power transmission through LDSBus Quad T-Junction
- Low power consumption 5V, 85mW
- High report rate of 1 report every 5 seconds
- Operating temperature range: 0°C to $+70^{\circ}\text{C}$
- Flush mount and DIN Rail Mount options
- Supported platform application: BRTSys's IoTPortal and LDSBus Python SDK (Visit <https://brtsys.com/resources>)



Neither the whole nor any part of the information contained in, or the product described in this manual, may be adapted, or Reproduced in any material or electronic form without the prior written consent of the copyright holder. This product and its documentation are supplied on an as-is basis and no warranty as to their suitability for any particular purpose is either made or implied. BRT Systems Pte Ltd (BRTSys) will not accept any claim for damages howsoever arising as a result of use or failure of this product. Your statutory rights are not affected. This product or any variant of it is not intended for use in any medical appliance, device, or System in which the failure of the product might reasonably be expected to result in personal injury. This document provides preliminary information that may be subject to change without notice. No freedom to use patents or other intellectual property rights is implied by the publication of this document. BRT Systems Pte Ltd, 1 Tai Seng Avenue, Tower A, #03-01 Singapore 536464. Singapore Registered Company Number: 202220043R.

2 Part Numbers

Part#	Description
LS030101A	LDSBus Thermocouple Sensor Adapter
LA120101A	LDSBus DIN Rail Mount Set

Table of Contents

1	Introduction	1
1.1	Features.....	1
2	Part Numbers	2
3	Specifications.....	4
4	Hardware Features.....	5
5	Sensor Configuration and Installation.....	6
5.1	Connection Diagram.....	6
6	Mounting Options	7
6.1	Flush Mount	7
6.2	DIN Rail Mount.....	7
7	System Status LED Indicators	8
8	Type-K Plug Interface Probe Standard	9
9	Mechanical Dimensions	10
10	Contact Information.....	11
Appendix A – References		12
Document References		12
Acronyms and Abbreviations.....		12
Appendix B – List of Figures and Tables.....		13
List of Figures		13
List of Tables.....		13
Appendix C – Revision History		14

3 Specifications

Features	Interface	K-type connector (connect to K-type probe), RS485
	LED Indicator (RGB)	System Status Indicator (Please refer to LED section)
	Mounting	Flush Mount DIN-Rail Mount
Power	Input Voltage	5V DC Bus Power
	Typical Power	85mW
	Max. Power	320mW
Thermocouple Sensor input module	Range	-200°C to +1372°C
	Accuracy	±0.5C
	Resolution	0.0625°C/ 0.25°C (Configurable)
	Response Time	<3 seconds
Physical Characteristics	Thermocouple Type	Type-K
	Color	White
	Housing	Polycarbonate
	Dimensions	L117.6mm x W42.9mm x H29.7mm
Environmental Limits	Operating Temperature	0 to 70°C
	Storage Temperature	-20 to 85°C
	Ambient Relative Humidity	5 to 95% (non-condensing)
Package Contents	Device	1x LDSBus Thermocouple Sensor Adapter
	Installation (Optional)	1x DIN Rail Bracket set
	Wire Assembly	1X 5m RJ11 Cable

Table 1 - LDSBus Thermocouple Sensor Adapter Specifications

4 Hardware Features

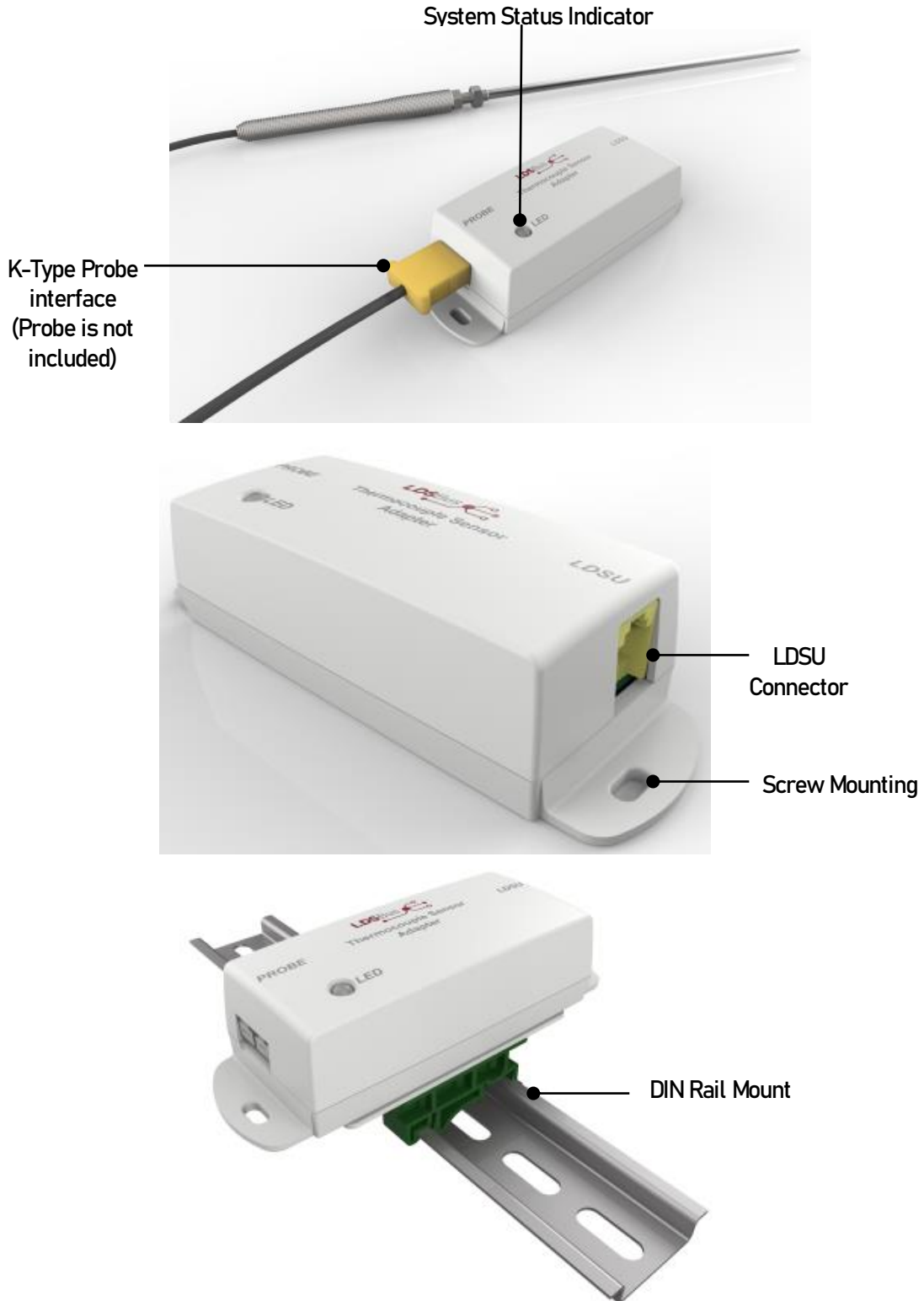

Figure 1 – LDSBus Thermocouple Sensor Adapter - Hardware Features

5 Sensor Configuration and Installation

Please visit <https://brtsys.com/resources> to access the LDSBus Configuration Utility Guide on how to configure the device name, address, and termination settings before using it for your application.

5.1 Connection Diagram

Figure 2 illustrates the connection of the LDSBus Thermocouple Sensor Adapter (LDSBus Device) to the LDS Bus. Please visit <https://brtsys.com/resources> to view the full device application, setup and installation guides.

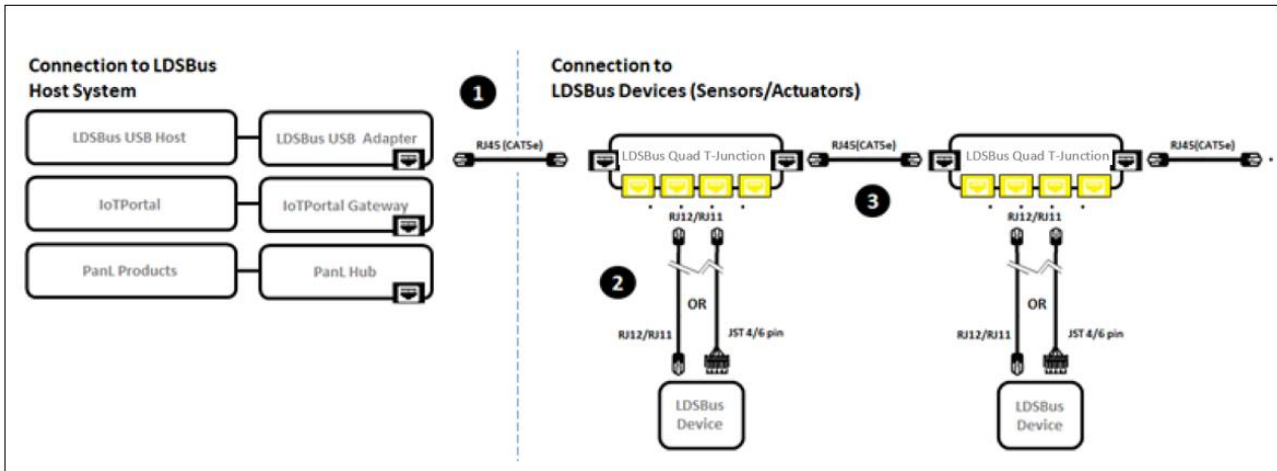

Figure 2 - LDSBus Thermocouple Sensor Adapter - Connection Diagram

Setup Instructions:

1. Connect the first LDSBus Quad T-Junction to any of the LDSBus Host Systems using the RJ45 (CAT5e) cable.
2. Connect the configured LDSBus Thermocouple Sensor Adapter to the LDSBus Quad T-Junction as shown in Figure 2.
3. If there is more than one LDSBus Quad T-Junction, chain them together as shown in Figure 2.

6 Mounting Options

6.1 Flush Mount

The LDSBus Thermocouple Sensor can be flush mounted directly on a wall or any flat surface using 2 M3.5*16mm (thread) screws.

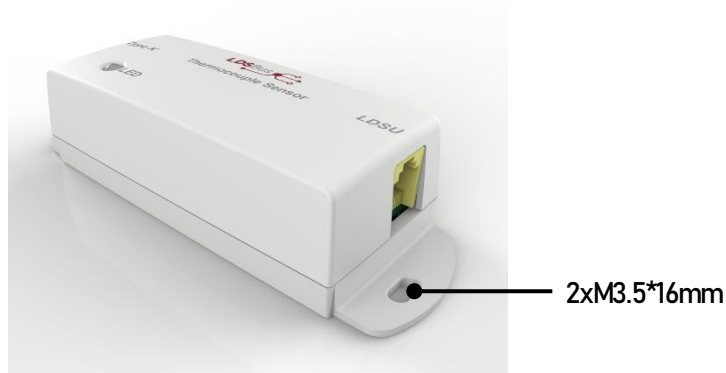

Figure 3 - LDSBus Thermocouple Sensor Adapter Flush Mount

6.2 DIN Rail Mount

The LDSBus Thermocouple Sensor can be mounted on a DIN Rail using the LDSBus DIN Rail Mount set. This set is optional and includes the bracket and mounting screws.



Figure 4 - LDSBus Thermocouple Sensor Adapter DIN Rail Mount

7 System Status LED Indicators

LDSU devices come with a tri-color LED, and LED status colors are mentioned in the table below.

Status display colors

- | | | | |
|----|--------|---|--|
| 1. | RED | - | Device in error conditions |
| 2. | YELLOW | - | Un-configured device |
| 3. | GREEN | - | Device in normal state (Device termination is OFF) |
| 4. | BLUE | - | Device in normal state (Device termination is ON) |









Device Status	LED Color		Flashing Frequency	Description
Un-configured device	YELLOW		LED flashing @1Hz	Un-configured device with factory default address (126)
Configured device	GREEN		Steady – Non-flashing	Configured device (Device ID 1-125) and device is idle.
	BLUE			
Addressed device	GREEN		LED flashing @5Hz	Device is busy communicating.
	BLUE			
Identified device	GREEN		LED flashing @1Hz	Device in identify state.
	BLUE			
Device error	RED		Steady – Non-flashing	Device error has occurred.
Firmware update	YELLOW		Steady – Non-flashing	Device firmware update.

Table 2 – LDSBus Thermocouple Sensor Adapter – System Status LED Indicator

8 Type-K Plug Interface Probe Standard

Table 3 provides a list of Type K Plugs to terminate Type K thermocouple probes for connection to LDSBus Thermocouple Sensor Adapter.

+ Contact	- Contact	IEC Miniature		ANSI Miniature		JIS Miniature	
		Color	Green	Color	Yellow	Color	Blue
Nickel Chromium	Nickel Alloy						

Table 3 - Type-K Plugs Interface

For information related to probes recommendation and selection criteria, please refer to [LDSBus Probe Specifications](#).

9 Mechanical Dimensions

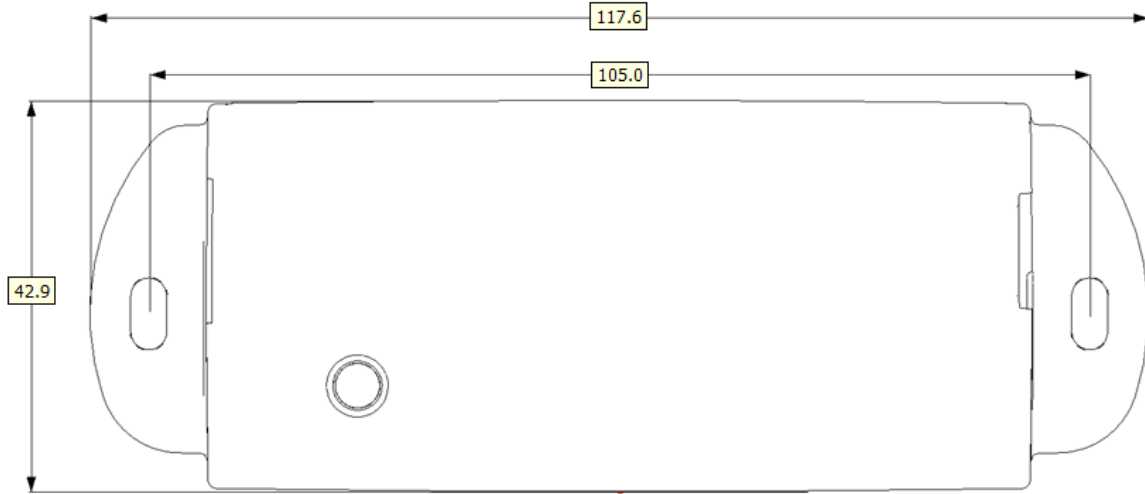

Figure 5 – LDSBUS Thermocouple Sensor Adapter Dimension – Top View

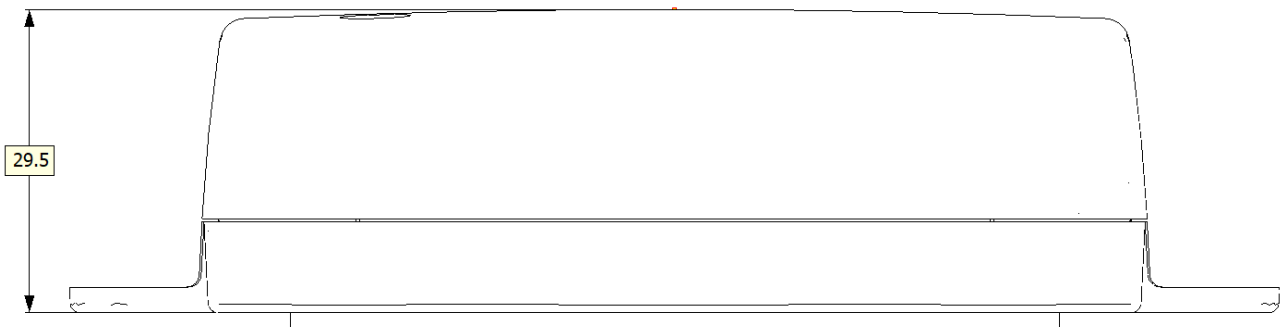

Figure 6 – LDSBUS Thermocouple Sensor Adapter Dimension – Side View

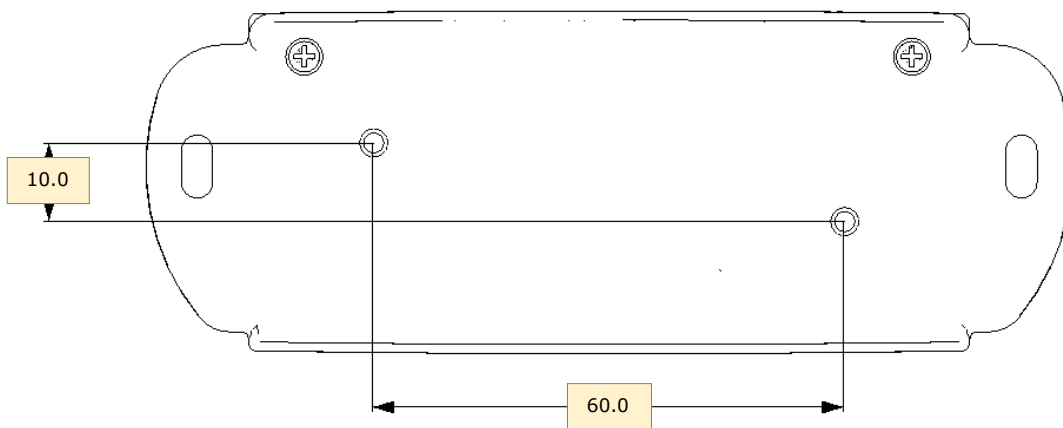

Figure 7 – LDSBUS Thermocouple Sensor Adapter Dimension – Bottom View

Note: All dimensions are in millimetres.

10 Contact Information

Refer to <https://brtsys.com/contact-us/> for contact information.

System and equipment manufacturers and designers are responsible to ensure that their systems, and any BRT Systems Pte Ltd (BRTSys) devices incorporated in their systems, meet all applicable safety, regulatory and system-level performance requirements. All application-related information in this document (including application descriptions, suggested BRTSys devices and other materials) is provided for reference only. While BRTSys has taken care to assure it is accurate, this information is subject to customer confirmation, and BRTSys disclaims all liability for system designs and for any applications assistance provided by BRTSys. Use of BRTSys devices in life support and/or safety applications is entirely at the user's risk, and the user agrees to defend, indemnify, and hold harmless BRTSys from any and all damages, claims, suits, or expense resulting from such use. This document is subject to change without notice. No freedom to use patents or other intellectual property rights is implied by the publication of this document. Neither the whole nor any part of the information contained in, or the product described in this document, may be adapted, or reproduced in any material or electronic form without the prior written consent of the copyright holder. BRT Systems Pte Ltd, 1 Tai Seng Avenue, Tower A, #03-01, Singapore 536464. Singapore Registered Company Number: 202220043R.

Appendix A – References

Document References

[BRTSYS AN 001 LDSBus Configuration Utility User Guide](#)

[BRTSYS API 001 LDSBus Python SDK Guide](#)

[Sensor Actuator QSG](#)

Acronyms and Abbreviations

Terms	Description
DC	Direct Current
IoT	Internet of Things
LED	Light Emitting Diode

Appendix B – List of Figures and Tables

List of Figures

Figure 1 – LDSBus Thermocouple Sensor Adapter - Hardware Features	5
Figure 2 - LDSBus Thermocouple Sensor Adapter - Connection Diagram.....	6
Figure 3 - LDSBus Thermocouple Sensor Adapter Flush Mount	7
Figure 4 – LDSBus Thermocouple Sensor Adapter DIN Rail Mount.....	7
Figure 5 – LDSBUS Thermocouple Sensor Adapter Dimension – Top View	10
Figure 6 – LDSBUS Thermocouple Sensor Adapter Dimension – Side View	10
Figure 7 – LDSBUS Thermocouple Sensor Adapter Dimension – Bottom View	10

List of Tables

Table 1 - LDSBus Thermocouple Sensor Adapter Specifications	4
Table 2 – LDSBus Thermocouple Sensor Adapter – System Status LED Indicator.....	8
Table 3 - Type-K Plugs Interface	9

Appendix C – Revision History

Document Title: LDSBus Thermocouple Sensor Datasheet
Document Reference No.: BRTSYS_000005
Clearance No.: BRTSYS#013
Product Page: <https://brtsys.com/ldsbus>
Document Feedback: [Send Feedback](#)

Revision	Changes	Date
Version 1.0	Initial Release	18-11-2021
Version 1.1	Updated release under BRT Systems	15-09-2022
Version 1.2	Corrected BRTSYS to BRTSys	24-03-2023
Version 1.3	Updated the following – HVT references to Quad T-Junction; Singapore address	11-09-2023