



LDSBus 4in1 Sensor Datasheet



1 Introduction

The LDSBus 4in1 Sensor consists of 4 sensors in a compact low-profile design. Temperature, humidity, Passive Infra-Red (PIR) based motion detection and ambient light measurement sensors are incorporated in this multi-sensor device. The device can be flush mounted on ceilings or swivel mounted on walls. The 4in1 Sensor works with the BRTSys's PanL Smart Living, IoTPortal and LDSBus Python SDK products.

1.1 Features

- 3 levels of motion sensitivity with customizable motion re-trigger interval and wide angle of motion detection
- Measures temperature up to 70°C with accuracy of $\pm 0.2^{\circ}\text{C}$
- Measures humidity from 0 to 95% with accuracy of $\pm 2\% \text{RH}$
- Measures ambient light up to 64K Lux
- Implements the BRTSys's LDSBus protocol.
- Low power consumption 5V, 180mW
- Operating temperature range: 0°C to +70°C
- Swivel mount and Flush mount options
- Supported platform application:
BRTSys's PanL Smart Living, IoTPortal and LDSBus Python SDK
(Visit <https://brtsys.com/resources>)



Neither the whole nor any part of the information contained in, or the product described in this manual, may be adapted, or Reproduced in any material or electronic form without the prior written consent of the copyright holder. This product and its documentation are supplied on an as-is basis and no warranty as to their suitability for any particular purpose is either made or implied. BRT Systems Pte Ltd (BRTSys) will not accept any claim for damages howsoever arising as a result of use or failure of this product. Your statutory rights are not affected. This product or any variant of it is not intended for use in any medical appliance, device, or System in which the failure of the product might reasonably be expected to result in personal injury. This document provides preliminary information that may be subject to change without notice. No freedom to use patents or other intellectual property rights is implied by the publication of this document. BRT Systems Pte Ltd, 1 Tai Seng Avenue, Tower A, #03-01 Singapore 536464. Singapore Registered Company Number: 202220043R.

2 Part Numbers

Part#	Description
LS010101A	LDSBus 4in1 Sensor (Motion, Temperature, Humidity & Brightness)-Flush
LS011101A	LDSBus 4in1 Sensor (Motion, Temperature, Humidity & Brightness)-Swivel

Table of Contents

1	Introduction	1
2	Part Numbers	2
3	Specifications	4
4	Hardware Features.....	5
5	PIR Sensor Detection Range	6
5.1	Flush Mount	6
5.2	Swivel Mount	7
6	Configuration, Installation & Application	8
6.1	Connection Diagram.....	8
7	Mounting Instructions.....	9
7.1	Flush Mount	9
7.2	Swivel Mount	10
8	System Status LED Indicators	13
9	Mechanical Dimension.....	14
10	Contact Information.....	15
Appendix A - References		16
Document References		16
Acronyms and Abbreviations		16
Appendix B - List of Figures and Tables		17
List of Figures		17
List of Tables		17
Appendix C – Revision History		18

3 Specifications

Features	Sensors	PIR Sensor Ambient Light Sensor Temperature Sensor Humidity Sensor
	Interface	RS485
	LED Indicator (RGB)	System Status Indicator (Please refer to LED section)
Power	Mounting	Flush Mount - Fixed Angle Installation Swivel Mount – Adjustable Angle Installation
	Input Voltage	5V DC Bus Power
	Max. Power	180mW
PIR Sensor	Detection Range (Swivel)	≤7 Meters (3 motion sensitivity levels - 3m,5m,7m)
	Max Install Height (Flush)	3 Meters
	Motion Angle	102.6 Degrees
Ambient Light Sensor	Motion re-trigger Interval	0-255 Seconds (Time lapse for motion to be reported again)
	Range	0 to 64000 Lux
	Range	0°C to 70°C (32F to 158F)
Temperature Sensor	Accuracy	±0.2°C (±32.36F)
	Resolution	0.1°C
	Range	0 to 95% RH
Humidity Sensor	Accuracy	±2% RH
	Color	White
	Housing	Polycarbonate
Physical Characteristics	Dimensions	62mm x H25mm (Flush) or 62mm x H60mm (Swivel)
	Operating Temperature	0 to 70°C
	Storage Temperature	-20 to 85°C
Environmental Limits	Ambient Relative Humidity	5 to 95% (non-condensing)
	Device	1X LDSBus 4in1 Sensor with Flush Mount (or) 1X LDSBus 4in1 Sensor with Swivel Mount
Package Contents	Wire Assembly	1X 5m RJ11-JST Cable
	Self-Tapping Screws	2X M3*16mm(Thread)
	Documentation	1x Quick Start Guide

Table 1 - LDSBus 4in1 Sensor Specifications

4 Hardware Features

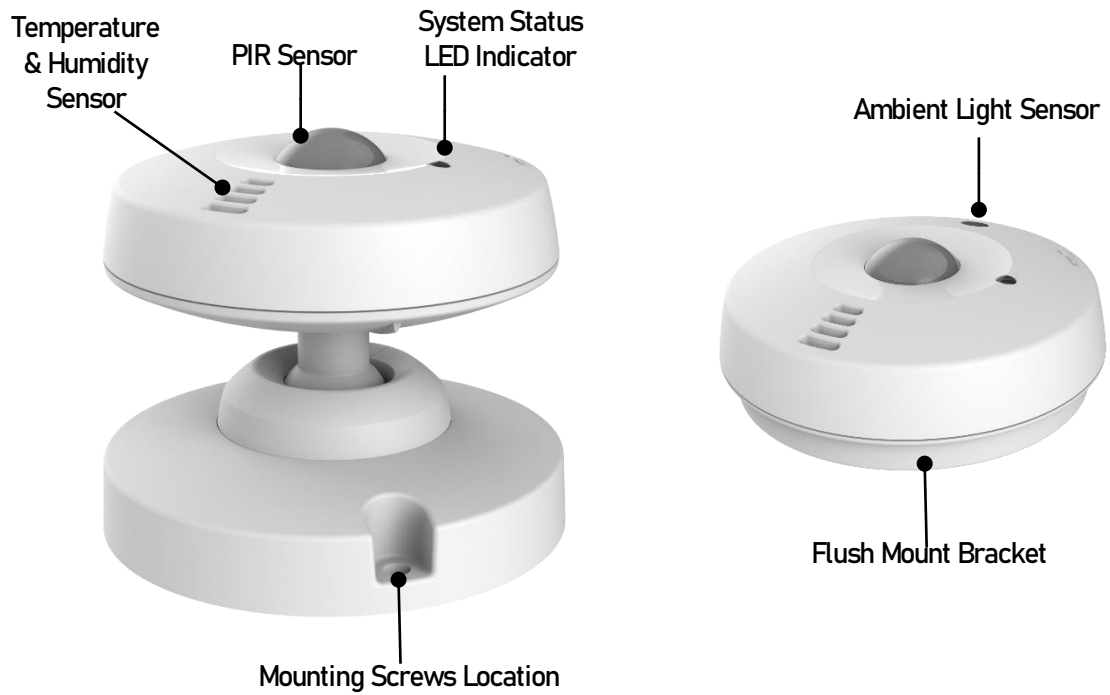

Figure 1 - LDSBus 4in1 Sensor Hardware Features

5 PIR Sensor Detection Range

5.1 Flush Mount

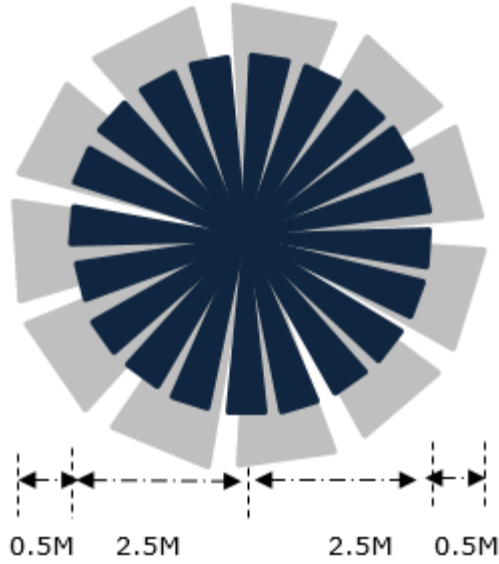

Figure 2 – LDSBus 4in1 Sensor - Flush Mount – Top View Projection

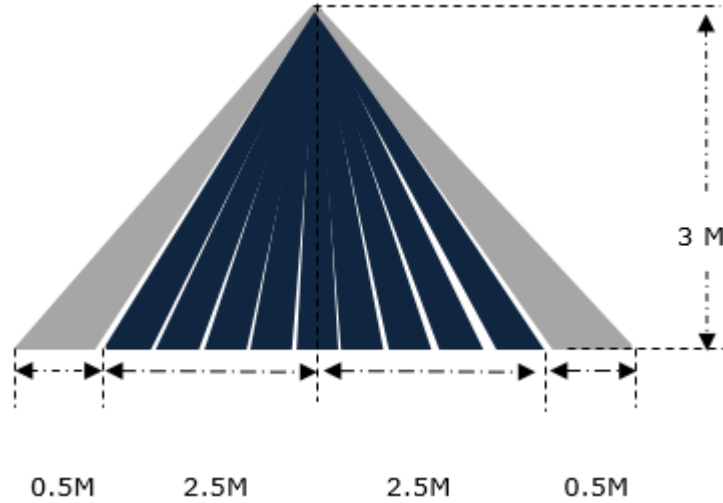

Figure 3 – LDSBus 4in1 Sensor - Flush Mount - Side View Projection

 **Major Motion**  **Minor Motion**

5.2 Swivel Mount

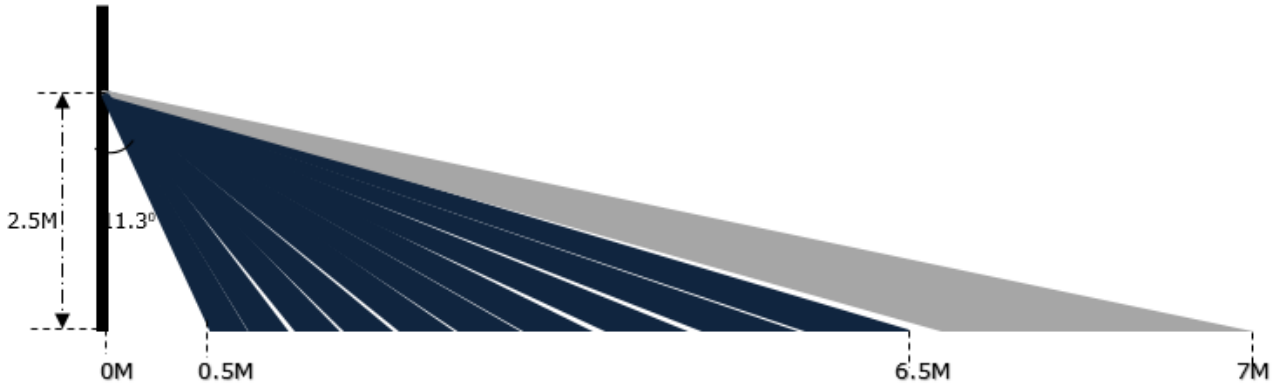

Figure 4 – LDSBus 4in1 Sensor - Swivel Mount - Side View Projection

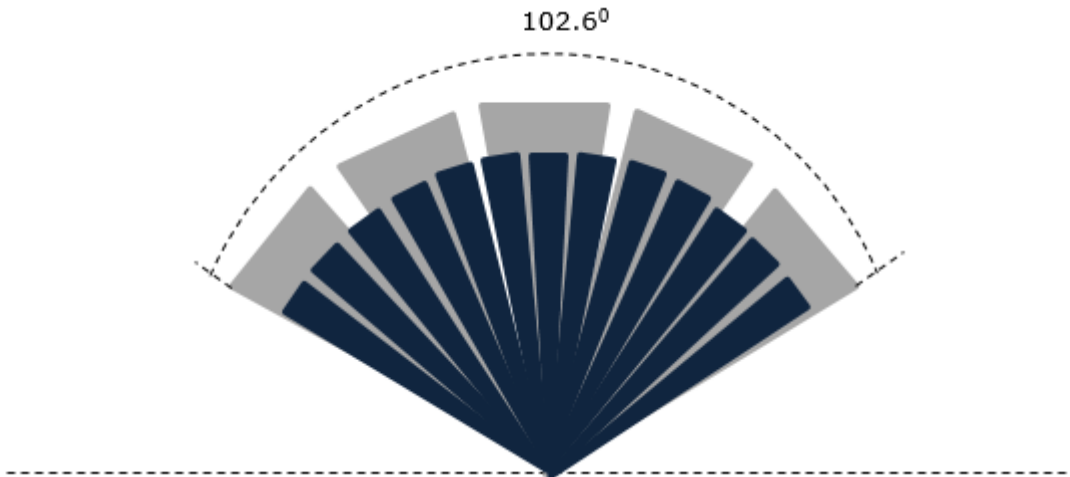

Figure 5 – LDSBus 4in1 Sensor - Swivel Mount - Top View Projection

Major Motion **Minor Motion**

Recommendation:

To avoid false motion detection, it is recommended to install the device away from direct light sources and heat generating equipment.

6 Configuration, Installation & Application

Please visit <https://brtsys.com/resources> to access the LDSBus Configuration Utility guide on how to configure the device name, device address and termination settings before using it for your specific application.

6.1 Connection Diagram

Figure 6 illustrates the connection of the LDSBus 4in1 Sensor (LDSBus Device) to the LDSBus. For more detailed information on device installation, setup, and application, please visit <https://brtsys.com/resources>.

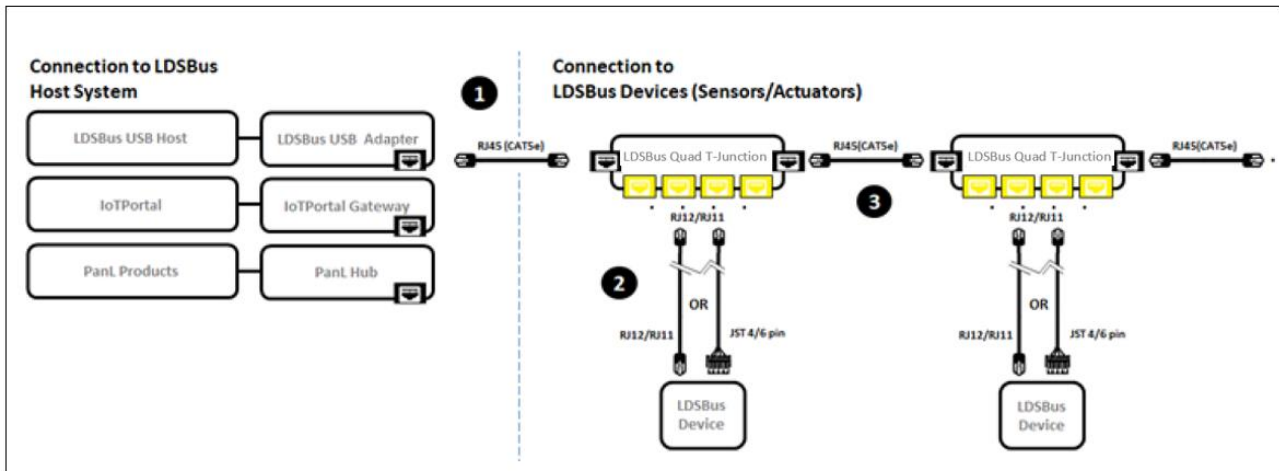

Figure 6 - LDSBus 4in1 Sensor to LDSBus - Connection Diagram

Setup Instructions:

1. Connect the first LDSBus Quad T-Junction to any of the LDSBus Host Systems using an RJ45 (CAT5e) cable.
2. Connect the configured LDSBus Multi Sensor to the LDSBus Quad T-Junction as shown in Figure 6.
3. If there is more than one LDSBus Quad T-Junction, chain them together as shown in Figure 6.

7 Mounting Instructions

Before mounting, ensure that the device has been configured using the LDSBus Configuration Utility.

7.1 Flush Mount

The flush mounting procedure assumes a flat hollow surface behind which the LDSBus RJ11-JST cable is concealed and made accessible through an opening. Figure 7 shows the front face of the LDSBus 4in1 Sensor device. Note the lock/unlock direction in the cover.



Figure 7 - LDSBus 4in1 Sensor

Follow these steps to fix the swivel mount –

1. Unlock the back cover. Twist the top cover in the anti-clockwise direction to unlock.



2. Make two holes in the back cover using the indentations as guides.

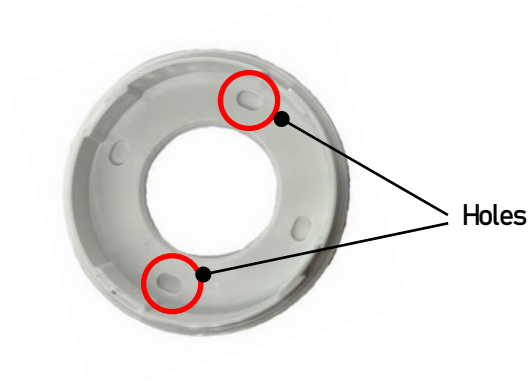

3. Prepare the ceiling and route the RJ11-JST cable through the ceiling opening. Run the LDSBus RJ11-JST cable through the centre (hole) of the back cover and fasten the back cover to the ceiling with self-tapping screws as shown in the picture below -

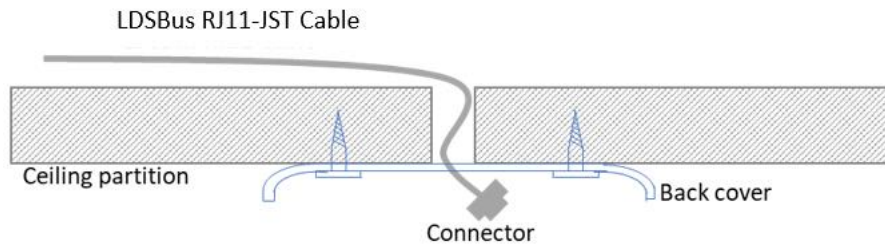

4. Attach the cable to the JST connector of the sensor.
5. Twist lock the front face, in a clockwise direction, to attach it to the back cover.

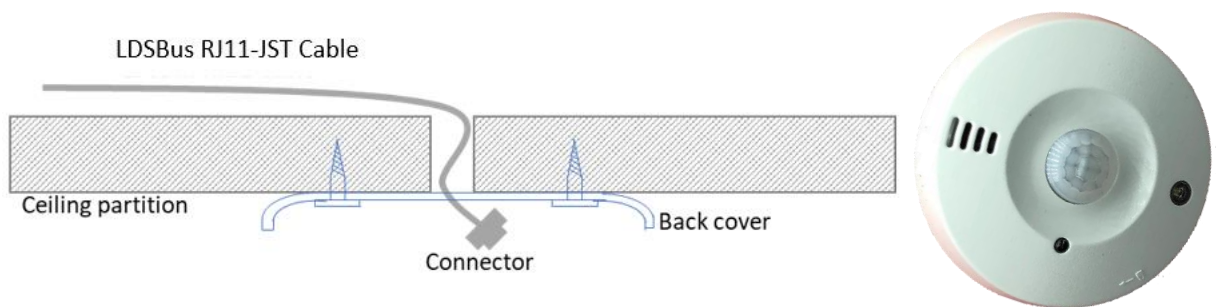

7.2 Swivel Mount

The swivel mount is shown in Figure 8.

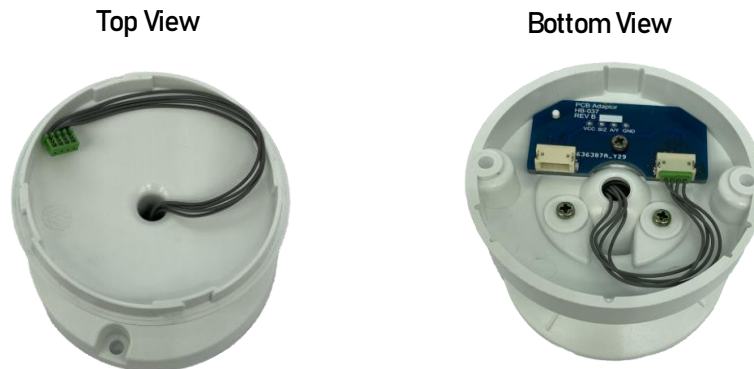
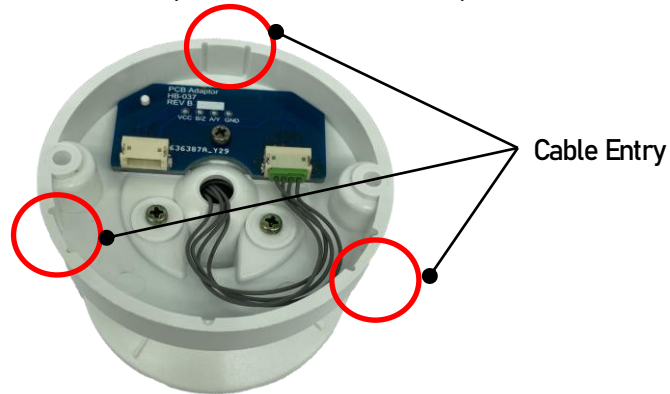

Figure 8 – LDSBus 4in1 Sensor - Swivel Mount – Top & Bottom View

Follow these steps to fix the swivel mount –

1. Choose the position for the wall mount and drill holes for mounting the swivel mount on the wall.
2. Route and affix the LDSBus RJ11-JST cable on the wall through a buried or wall mounted conduit to butt against the base of the swivel mount.

3. Break off one of the three cable entry locations on the base plate for cable routing.



4. Connect the LDSBus RJ11-JST cable to the JST connector (Swivel Mount bottom section) as shown in the Figure.



5. Fasten the swivel mount to the wall using the mounting screws. Ensure that the cable is sitting in the cable entry slot.
6. Remove the sensor from the flush mount back cover by turning it in an anti-clockwise direction.



7. Connect the JST cable from the top section of the swivel mount to the JST connector located on the back of the device.



8. Attach the device to the top section of the swivel mount.



9. Turn the device clockwise to secure it to the swivel mount.



8 System Status LED Indicators

LDSU devices come with a tri-color LED. The LED status colors are described in the table below.

Status display colors

1. RED - Device in error condition
2. YELLOW - Un-configured device
3. GREEN - Device in normal state (Device termination is OFF)
4. BLUE - Device in normal state (Device termination is ON)









Device Status	LED Color		Flashing Frequency	Description
Un-configured device	YELLOW		LED flashing @1Hz	Un-configured device with factory default address (126)
Configured device	GREEN		Steady – Non-flashing	Configured device (Device ID 1-125) and device is idle.
	BLUE			
Addressed device	GREEN		LED flashing @5Hz	Device is busy communicating.
	BLUE			
Identified device	GREEN		LED flashing @1Hz	Device in identify state.
	BLUE			
Device error	RED		Steady – Non-flashing	Device error has occurred.
Firmware update	YELLOW		Steady – Non-flashing	Device firmware update.

Table 2 – LDSBus 4in1 Sensor – System Status LED Indicator

9 Mechanical Dimension

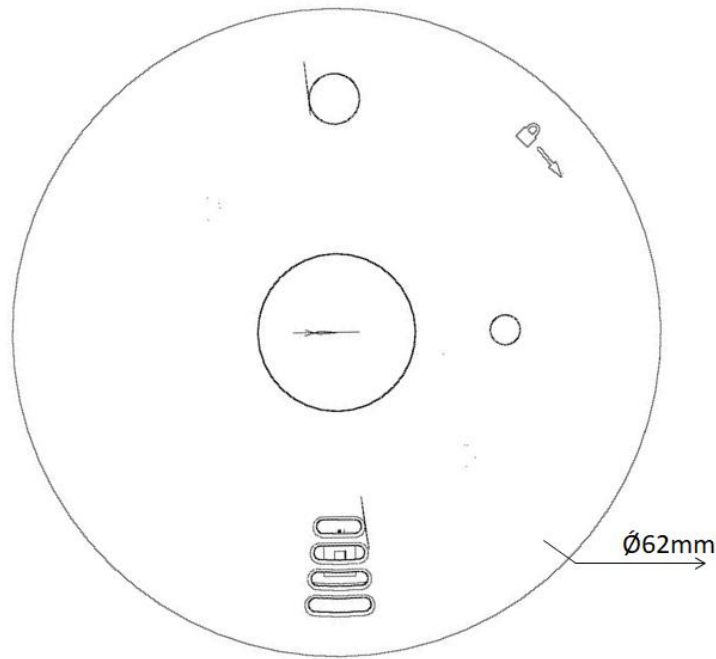

Figure 9 – LDSBus 4in1 Sensor Dimension – Top View

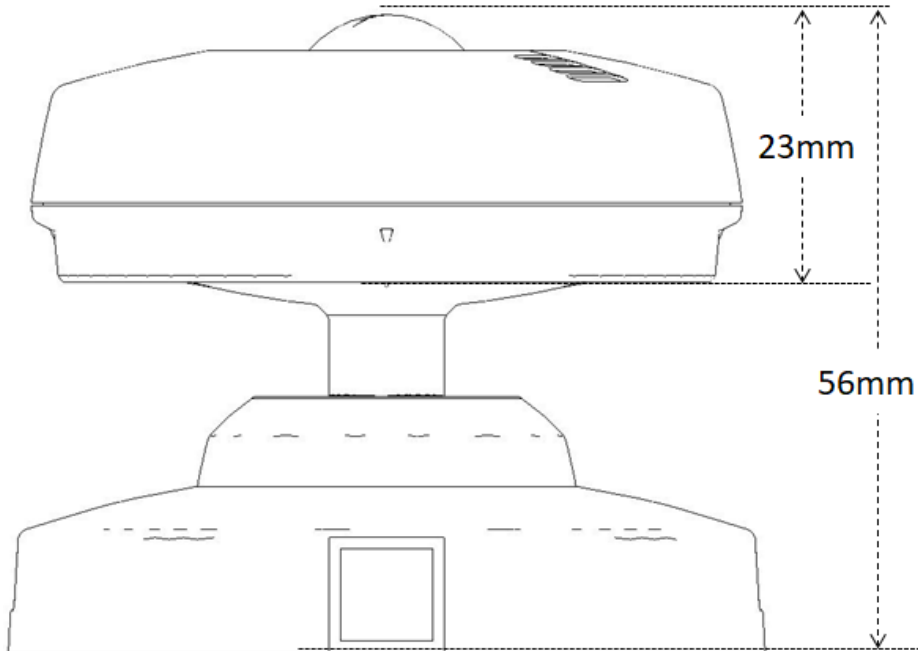

Figure 10 – LDSBus 4in1 Sensor Dimension – Side View

Note: All dimensions are in millimetres.

10 Contact Information

Refer to <https://brtsys.com/contact-us/> for contact information.

System and equipment manufacturers and designers are responsible to ensure that their systems, and any BRT Systems Pte Ltd (BRTSys) devices incorporated in their systems, meet all applicable safety, regulatory and system-level performance requirements. All application-related information in this document (including application descriptions, suggested BRTSys devices and other materials) is provided for reference only. While BRTSys has taken care to assure it is accurate, this information is subject to customer confirmation, and BRTSys disclaims all liability for system designs and for any applications assistance provided by BRTSys. Use of BRTSys devices in life support and/or safety applications is entirely at the user's risk, and the user agrees to defend, indemnify, and hold harmless BRTSys from any and all damages, claims, suits, or expense resulting from such use. This document is subject to change without notice. No freedom to use patents or other intellectual property rights is implied by the publication of this document. Neither the whole nor any part of the information contained in, or the product described in this document, may be adapted, or reproduced in any material or electronic form without the prior written consent of the copyright holder. BRT Systems Pte Ltd, 1 Tai Seng Avenue, Tower A, #03-01, Singapore 536464. Singapore Registered Company Number: 202220043R.

Appendix A - References

Document References

[BRTSYS AN 001 LDSBus Configuration Utility Guide](#)

[BRTSYS API 001 LDSBus Python SDK Guide](#)

Acronyms and Abbreviations

Terms	Description
DC	Direct Current
LED	Light Emitting Diode
PIR	Passive infrared sensor

Appendix B - List of Figures and Tables

List of Figures

Figure 1 - LDSBus 4in1 Sensor Hardware Features	5
Figure 2 - LDSBus 4in1 Sensor - Flush Mount – Top View Projection	6
Figure 3 - LDSBus 4in1 Sensor - Flush Mount - Side View Projection	6
Figure 4 - LDSBus 4in1 Sensor - Swivel Mount - Side View Projection.....	7
Figure 5 - LDSBus 4in1 Sensor - Swivel Mount - Top View Projection.....	7
Figure 6 - LDSBus 4in1 Sensor to LDSBus - Connection Diagram.....	8
Figure 7 - LDSBus 4in1 Sensor.....	9
Figure 8 - LDSBus 4in1 Sensor - Swivel Mount – Top & Bottom View	10
Figure 9 - LDSBus 4in1 Sensor Dimension – Top View	14
Figure 10 - LDSBus 4in1 Sensor Dimension – Side View	14

List of Tables

Table 1 - LDSBus 4in1 Sensor Specifications.....	4
Table 2 - LDSBus 4in1 Sensor – System Status LED Indicator	13

Appendix C – Revision History

Document Title: LDSBus 4in1 Sensor Datasheet
Document Reference No.: BRTSYS_000006
Clearance No.: BRTSYS#006
Product Page: <https://brtsys.com/ldsbus/>
Document Feedback: [Send Feedback](#)

Revision	Changes	Date
Version 1.0	Initial Release	16-11-2021
Version 1.1	Updated release under BRT Systems	15-09-2022
Version 1.2	Updated Multi-Sensor references to 4in1 sensor	24-03-2023
Version 1.3	Updated the following – HVT references to Quad T-Junction; Singapore address	11-09-2023